

CS(AR) 2/98-99

DETERMINATION OF HYDRAULIC CONDUCTIVITY OF SOILS IN CENTRAL BIHAR



जलमे ही हमारे जीवन

NATIONAL INSTITUTE OF HYDROLOGY
JALVIGYAN BHAWAN
ROORKEE - 247 667
1998-99

PREFACE

Physically based hydrological models, soil water balance, groundwater flow and transport models require saturated and unsaturated hydraulic conductivity to solve the sub-surface flow and transport equations. Several field, laboratory and predictive methods are available for determination of this parameter. However these methods have some advantages and some limitations with respect to their operation etc. Guelph Permeameter is used as a tool to determine the field hydraulic conductivity even when the water table is low. It is portable, durable and allows rapid field calculation of saturated and unsaturated hydraulic conductivity.

Predictive methods (using empirical formulae) are also in use to determine hydraulic conductivity using bulk density, porosity, water content etc. which are easy to determine.

The study reported here gives a systematic methodology to determine field hydraulic conductivity using Guelph Permeameter, its limitations based on the experiences gained in the field and a comparison of its result with that estimated from the predictive method. The report entitled "Determination of Hydraulic Conductivity of Soils in Central Bihar" has been prepared by Sri Biswajit Chakravorty, Scientist 'C' and Sri N.G.Pandey, Scientist 'B' with the assistance from Sri A.K.Sivdas who helped in carrying out the soil sample collections and field experiments.



(S.M. Seth)

TABLE OF CONTENTS

PREFACE	i
LIST OF FIGURES	iv
LIST OF TABLES	v
1.0 INTRODUCTION	1
1.1 Significance of Hydraulic Conductivity.	1
1.2 Methods to determine Hydraulic Conductivity	3
1.3 Present Study and Objective	3
2.0 REVIEW OF LITERATURE	4
2.1 Darcy's Law	4
2.1.1 Dependence of Hydraulic Conductivity	4
2.2 Measurement and Estimation of Hydraulic Conductivity	6
2.2.1 Direct methods (using field techniques)	6
2.2.1.1 Auger hole method	6
Construction	7
Computation of K_s by Ernst formula	8
Computation of K_s by Hooghoudt's method	11
2.2.1.2 Guelph Permeameter method	11
2.2.2 Direct methods (using laboratory methods)	12
2.2.2.1 Construction of a ring holder	12
2.2.2.2 Principles of ICW Permeameter	13
2.2.2.3 Constant head method	14
2.2.2.4 Falling head method	15
2.2.3 Indirect method for Estimation of Hydraulic Conductivity	15
3.0 STUDY AREA	16
3.1 Soil Type	16
4.0 MATERIAL AND METHODS	17
4.1 Direct measurement by Guelph Permeameter	17
4.1.1 Computation of K_{fs} , Φ_m , S , α , and $K(\Psi)$	18
4.1.1.1 Field saturated hydraulic conductivity	18
4.1.1.2 Matrix flux potential (Φ_m)	20
4.1.1.3 Sorptivity (S)	20

4.1.1.4	Alfa constant (α)	20
4.1.1.5	Conductivity- Pressure Head relationships ($K\Psi$)	20
4.1.2	Operation of Guelph Permeameter	21
4.1.2.1	Well preparation	22
4.1.2.2	Permeameter placement	22
4.2	Indirect method through soil properties	24
4.2.1	Collection of soil samples	24
4.2.2	Determination of initial moisture content and Bulk density	24
4.2.3	Removal of Carbonates, Organic matter, Iron oxides and Soluble salts	25
4.2.4	Separation of fractions to be sieved	26
4.2.5	Particle size distribution by Master Sizer	26
4.2.6	Classification of soils by soil texture triangle	26
4.2.7	Estimation of soil water suction	28
4.2.8	Estimation of water content	29
4.2.9	Estimation of saturated hydraulic conductivity	29
4.2.10	Estimation of Unsaturated hydraulic conductivity	32
5.0	RESULTS AND DISCUSSIONS	33
6.0	RECOMMENDATIONS	41
7.0	REFERENCES	43

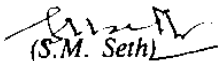
LIST OF FIGURES

2.1	The Auger Hole method	7
2.2	Nomograph for determination of C in Auger Hole method for $S > 0.5H$ (Ernst, 1950).	9
2.3	Nomograph for determination of C in Auger Hole method for $S = 0$ (Ernst, 1950).	10
2.4	Parts of a ring holder	12
2.5	Working principle of ICW Laboratory Permeameter	13
2.6	Reading by Falling head method	15
4.1	Standard curve for 'C' factor	19
4.2	Different parts of a Guelph Permeameter	21
4.3	Permeameter placement	22
4.4	Particle Size Distribution ranges for various classification	27
4.5	Soil texture triangle.	28
4.6	Water Retention Curves for USDA Soil Textures	29
4.7	Saturated Hydraulic Conductivity sorted by USDA soil triangle	30
4.6	Hydraulic Conductivity sorted by soil texture	30
5.1	Effective porosity v/s Estimated K_s and Measured K_s curve	37
5.2	Silt percentage v/s Saturated Conductivity curve	38
5.3	Unsaturated Hydraulic Conductivity estimated from the graph K/K_s v/s Degree of Saturation.	39

LIST OF TABLES

2.1	Range of Hydraulic Conductivity of unconsolidated to semi-consolidated formations.	5
2.2	Hydraulic Conductivity as per USDA classification	6
4.1	Water retention properties classified by soil texture	31
5.1	Calculation of Bulk density	33
5.2	Estimated and measured Hydraulic Conductivity of soils of West Bengal	34
5.3	Estimated and measured Hydraulic Conductivity of soils of study area	35
5.4	Estimated and measured K_s	36

1.0 INTRODUCTION

1.1 Significance of Hydraulic Conductivity

The hydraulic conductivity is a measure of the ability of the soil to transmit water. To evaluate the potential use of soil for many agricultural and non-agricultural uses, the hydraulic conductivity K of the soil need to be known. In practice, hydraulic conductivity need to be measured at several places because of its spatial variability.

Hydraulic conductivity is needed to describe how soil solution moves through the soil. This is useful for studying irrigation, water logging and drainage, erosion, soil water balance studies and other sub-soil problems. It is also an important parameter for studying the sub-surface flow and transport problems.

Thus, hydraulic conductivity is an important parameter frequently used to assess the following:

- Estimation of subsurface drain spacing, size of drain and volume of water that may be removed from water logged areas.
- Assessing the quantity of ground water recharge.

Movement of water also takes place in unsaturated soil condition. Had there been no water movement under the unsaturated condition, there would probably be no plant growth on the earth surface. Soil in the unsaturated zone exists in the saturated condition so long as either irrigation or rainfall continues. Immediately thereafter, an unsaturated condition develops. It is known that plants respond to water application at a particular soil suction and yields are maximum. Thus it is important that the suction should not go beyond the critical suction limits.

Among the water transmission characteristics of soil - saturated hydraulic conductivity, unsaturated hydraulic conductivity and soil water diffusivity are important. Three of the most important parameters governing liquid transmission in the vadose zone include saturated hydraulic conductivity (K_s), sorptivity(S) and the hydraulic conductivity-pressure head relationship $K(\psi)$.

Soil texture, structure, and organic matter content have significant influence on

hydraulic conductivity. Hydraulic conductivity is more in coarse textured, sandy soil - but, capillary conductivity is higher in loam, sandy loam and clay loam soils than sandy soil, due to better continuity of pores in fine textured soils. Particle size distribution affects the continuity of capillary pores and appears as a dominant factor affecting water transmission characteristics.

Macropores conducts better, when they forms a continuous path through soil body. If, however, macropores are distributed spatially at random with micropores as under natural condition, conductivity may be lower.

Constant head well permeameter (GP) method given by Renold is a practical and valid means for in situ measurement of field saturated hydraulic conductivity K_s above the water table but its basic theory neglects the effects of unsaturated flow. An extended CWHP theory was developed, that deterministically accounts for unsaturated flow.

Unsaturated water transmission characteristics of soil is influenced by texture and aggregate size of the soil pores. In soils of different textures, K follows the order, loamy sand, sandy loam, clay loam. Increase in soil water content increases of both hydraulic conductivity and soil water diffusivity but the value decreases with rise in soil water tension.

Changes of bulk density in soil cause variation in pore geometry. It influences pathways of water flowing through the soil. Reduced hydraulic conductivity with high bulk density has been reported by several workers. Increase in bulk density due to puddling and compaction under field condition decreases saturated conductivity drastically.

1.2 Methods to Determine Hydraulic Conductivity

Various indirect and direct techniques have been developed for determination of hydraulic conductivity. This is a tedious and time consuming task. Indirect determination is by knowing other physical properties such as soil texture, bulk density, porosity etc. which are easy to determine and can be used through empirically developed relations to estimate field hydraulic conductivity.

Guelph Permeameter is a latest development for direct in-situ determination of field saturated hydraulic conductivity. This is a constant head well permeameter that creates a saturated bulb at a desired depth to measure steady rate of water entry into the soil. The rate of water entry, so obtained, is used to determine the saturated hydraulic conductivity.

1.3 Present Study and Objectives

In the present study Guelph Permeameter has been used for determination of hydraulic conductivity in three depths at a location in central part of Bihar and other locations having similar soil conditions. In each setting, K has been calculated at three different depths at 50 cm, 100 cm, and 150 cm at the same location or nearby.

Same soil samples are taken for textural analysis, determination of bulk density and initial water content. Using these informations and empirically developed relations, the saturated hydraulic conductivity was estimated. The estimated values have been compared with the in-situ measured hydraulic conductivity found by using Guelph permeameter. The causes of deviation have been analyzed.

This report is rather a systematic representation of the methodology to be followed for hydraulic conductivity determination. Thus, objectives of the present study can be stated as under:

- To determine the in-situ hydraulic conductivity using the Guelph Permeameter.
- To compare the hydraulic conductivity values found by Guelph permeameter and the indirectly estimated one using other soil properties.

2.0 REVIEW OF LITERATURE

2.1 Darcy's Law

Darcy's law states that the rate of flow through a porous medium is proportional to the loss of head, and inversely proportional to the length of the flow path, or

$$v = K (dh/dl)$$

where,

v	=	Q/A is the specific discharge or the Darcy's velocity [LT^{-1}],
Q	=	Volumetric rate of flow [L^3T^{-1}],
A	=	Cross-sectional area normal to the flow direction [L^2],
dh	=	Head loss [L] between two points,
dl	=	Distance between two points [L],
dh/dl	=	i , is the hydraulic gradient [],
K	=	Constant of proportionality known as the hydraulic conductivity [LT^{-1}].

2.1.1 Dependence of K

Hydraulic conductivity of a porous media is the discharge through a unit area under a unit hydraulic gradient.

Permeability (k) is the ease with which the water moves within the soil. It depends upon the properties of the medium only. Hydraulic conductivity (K), depends on both the properties of the medium as well as the fluid passing through it.

$$\begin{aligned}v &\propto d^2 \\v &\propto \rho g \\v &\propto 1/\mu\end{aligned}$$

where,

d	=	diameter of the soil particle [L],
ρ	=	density of fluid [ML^{-3}],
g	=	acceleration due to gravity [LT^{-2}],
μ	=	dynamic viscosity of fluid [$KL^{-2}T$],
dh/dl	=	hydraulic gradient [].

Darcy originally observed, velocity is proportional to dh/dl . Together with the above three relationships, lead to a new version of Darcy's law.

$$v = \frac{Cd^2\rho g}{\mu} \frac{dh}{dl}$$

The parameter C is yet another dimensionless constant of proportionality that depends on the distribution of grain size, roundness of grains, and nature of packing. In the above equation ρ and μ are functions of the fluid alone and Cd^2 is a function of medium alone. Permeability may be defined

$$k = Cd^2$$

$$K = (k\rho g)/\mu$$

If K is always called hydraulic conductivity, then k may be referred as intrinsic permeability or simply permeability.

Table 2.1: Range of Hydraulic Conductivity of unconsolidated to semi-consolidated formations.

Sl	Nature of Material	Type of Material	Range of Hydraulic Conductivity(m/day)
1.	Gravel	Coarse	50 - 100
		Medium	40 - 50
		Fine	30 - 40
2.	Sand	Gravel to very coarse	40 - 50
		Very coarse	30 - 40
		Very coarse to coarse	25 - 30
		Coarse	20 - 25
		Coarse to medium	10 - 20
		Medium	5 - 10
		Medium to fine	3 - 5
		Fine	1 - 3
	Loam	0.1 - 0.5	
3.	Clay	Clay	≤ 0.001

Source: Chachadi,A.G,& Mishra,G.C. Review note RN-9,1984-85, NIH,Roorkee,p-28.

Table 2.2: Hydraulic conductivity as per USDA soil classification.

Sl	Soil texture class	Saturated hydraulic conductivity(cm/hr)	Saturated hydraulic conductivity(m/day)
1.	Sand	23.56	5.65
2.	Loamy sand	5.98	1.43
3.	Sandy loam	2.18	0.52
4.	Loam	1.32	0.31
5.	Silty loam	0.68	0.16
6.	Sandy clay loam	0.30	0.07
7.	Clay loam	0.20	0.05
8.	Silty clay loam	0.20	0.05
9.	Sandy clay	0.12	0.03
10.	Silty clay	0.10	0.02
11.	Clay	0.06	0.01

(Source: David, R. Maidment, 1992. Handbook of Hydrology, pp-5.34)

2.2 Measurement and Estimation of Hydraulic Conductivity

Saturated hydraulic conductivity can be found *directly* by measuring water movement through a soil sample, or *indirectly*, by estimating from associated soil properties. Methods that measures saturated hydraulic conductivity can be divided into two categories.

2.2.1 Direct method (using field techniques)

2.2.1.1 By Auger hole method

This method is applicable to measure hydraulic conductivity in situ below a water table. A hole is bored into the soil with an auger to a certain depth below the water table. When the water in the hole reaches equilibrium with the groundwater, part of it is removed. The groundwater then begins to seep into the hole and rate at which it rises is measured. The hydraulic conductivity of the soil is then found using standard formula given by Ernst and Hooghoudt or by using graph describing the relation between the rate of rise, the groundwater conditions and the geometry of the hole. This method measures the average

hydraulic conductivity of a soil column about 30 cm in radius and extending about 20 cm below the bottom of the hole from groundwater table, or to a relatively impermeable layer if it occurs within 20 cm from the bottom of the hole. (Mishra, G.C 1996. Drainage manual).

Construction

A simple and convenient measuring equipment has been developed that has a tube of 60 cm long, the bottom of which is fitted with a valve that can act as a bailer. Extension pieces can be added to the top of the tube. A float, a light weight steel tape, and a standard fixed level are also a part of the equipment. The standard fixed level is pressed into the soil upto a certain mark, so that water level readings can be taken at a fixed height above the ground surface.

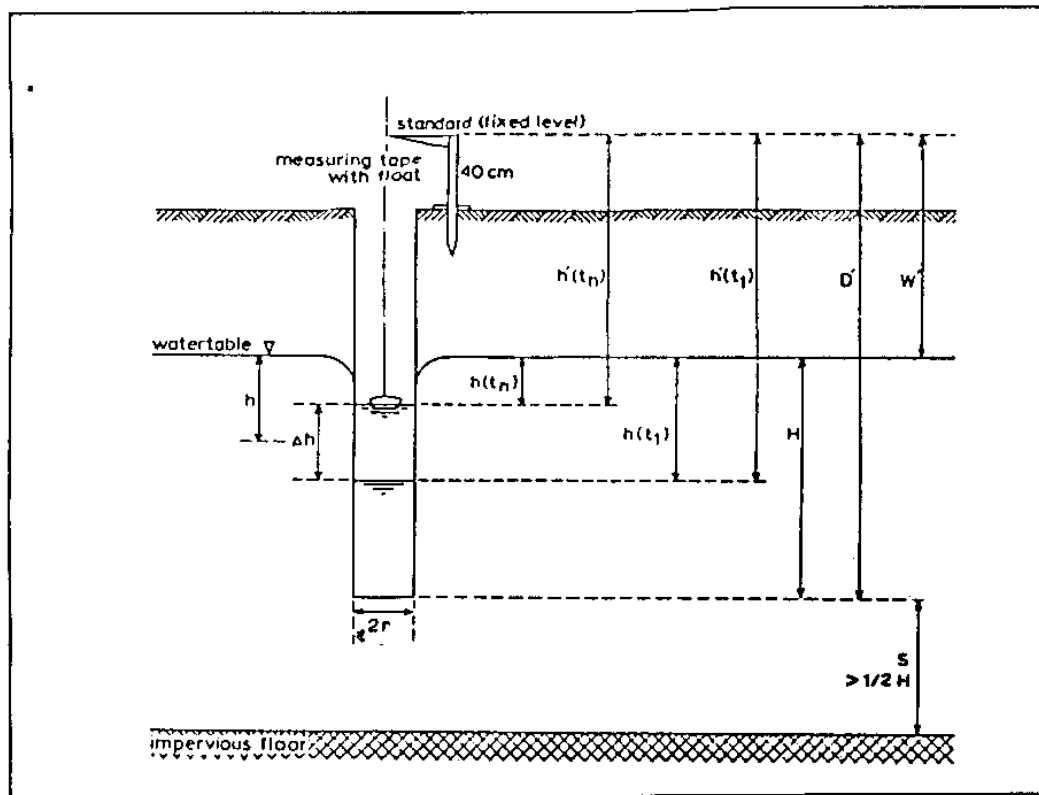

Figure 2.1: The Auger Hole method

where,

- D' = Depth of auger hole below level of the standard.
- W' = Depth of water table below level of the standard.

- H = $D' - W'$, depth of auger hole below water table.
 $h'(t_1)$ and $h'(t_n)$ = Depth of water table in the hole below standard level at the time of the first reading (t_1) and after some time (t_n).
 Δh = $h'(t_1) - h'(t_n)$ the rise of water level in the hole during the time of measurements.
 h = $h'(t_1) - 0.5\Delta h$.
 S = Depth of impervious floor below the bottom of the hole.
 r = Radius of the hole.

The hole must be made with a minimum disturbances to the soil. The depth of the hole depends on the nature, thickness, sequence of soil layers and the depth upto which it is required to determine hydraulic conductivity. When the water level in the hole is in equilibrium with the groundwater, the level is recorded. Water is then bailed out to lower the level in the hole by 20 - 40 cm. The rate of rise in the water level is to be measured immediately after bailing. Normally some 5 readings are taken, as these will give a reliable average value for the rate of rise and also provide a check against irregularities. The time interval at which water level readings are taken is usually from 5-30 seconds. Care needs to be taken to complete the measurements before 25% of the volume of water removed from the hole has been replaced by inflowing groundwater. After that a considerable funnel shaped water table develops around the top of the hole. This increases resistance into the flow around and into the hole. This effect is not accounted for in the formulae or flow charts developed for auger hole method.

Computation of K_s by Ernst formula

For one layered soil Ernst (1950) found that the relation between the hydraulic conductivity of the soil and the flow of water into the auger hole depends on the boundary conditions. This relation has been derived numerically and is given as:

$$K_s = C \left(\frac{\Delta h}{\Delta t} \right) \quad (2.1)$$

where,

- $\Delta h/\Delta t$ = Measured rate of rise in cm/sec.
 C = Dimensionless constant which is a function of H, h, r and S as given in the nomograph and a function of h/r and H/r for $S > 0.5H$ given in Figure 2.2 Figure 3.3 represents C as a function of $h/r, H/r$ for $S=0$.
 K_s = Saturated hydraulic conductivity in m/day.

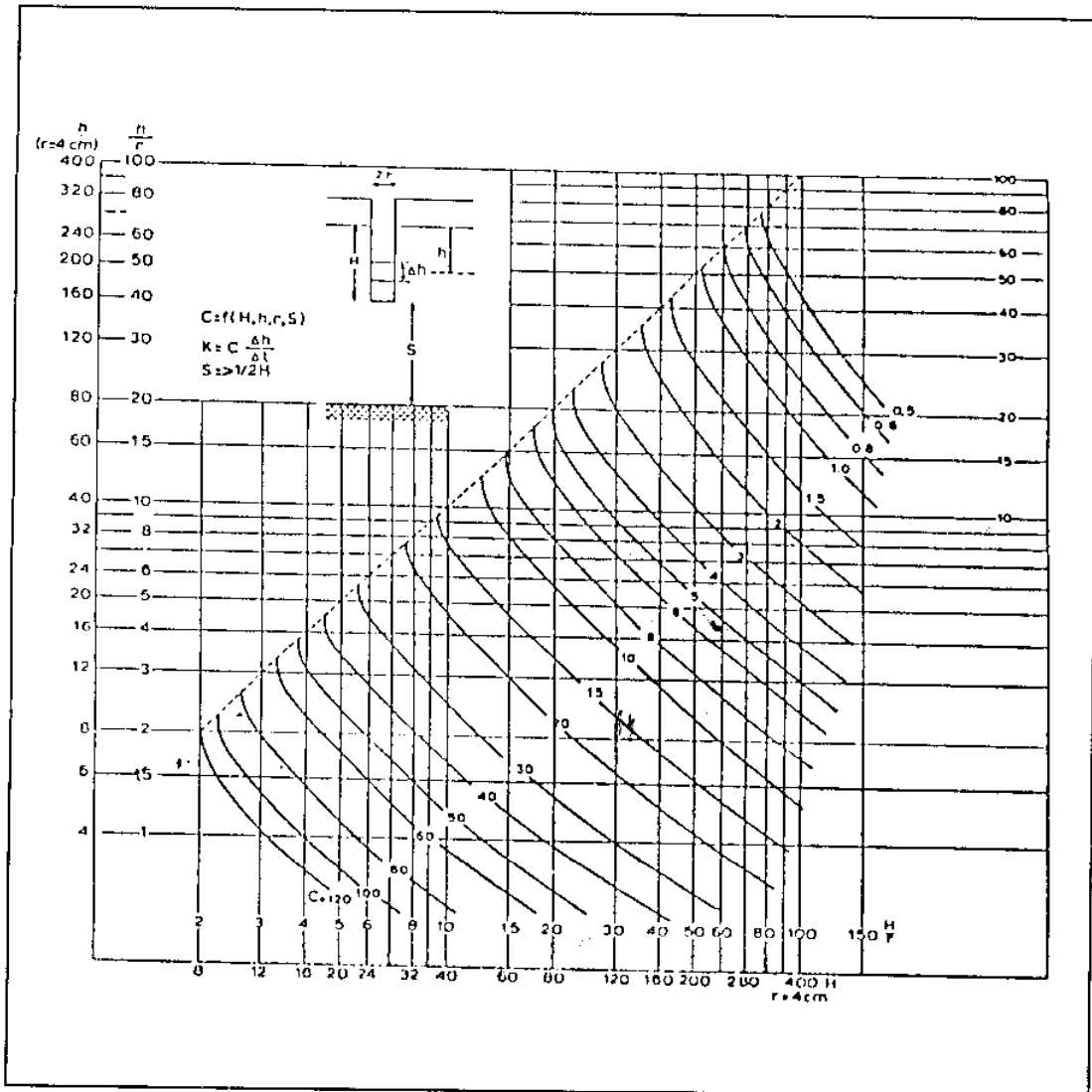

Figure 2.2: Nomograph for determination of C in Auger-Hole method for $S > 0.5H$ (Ernst, 1950).

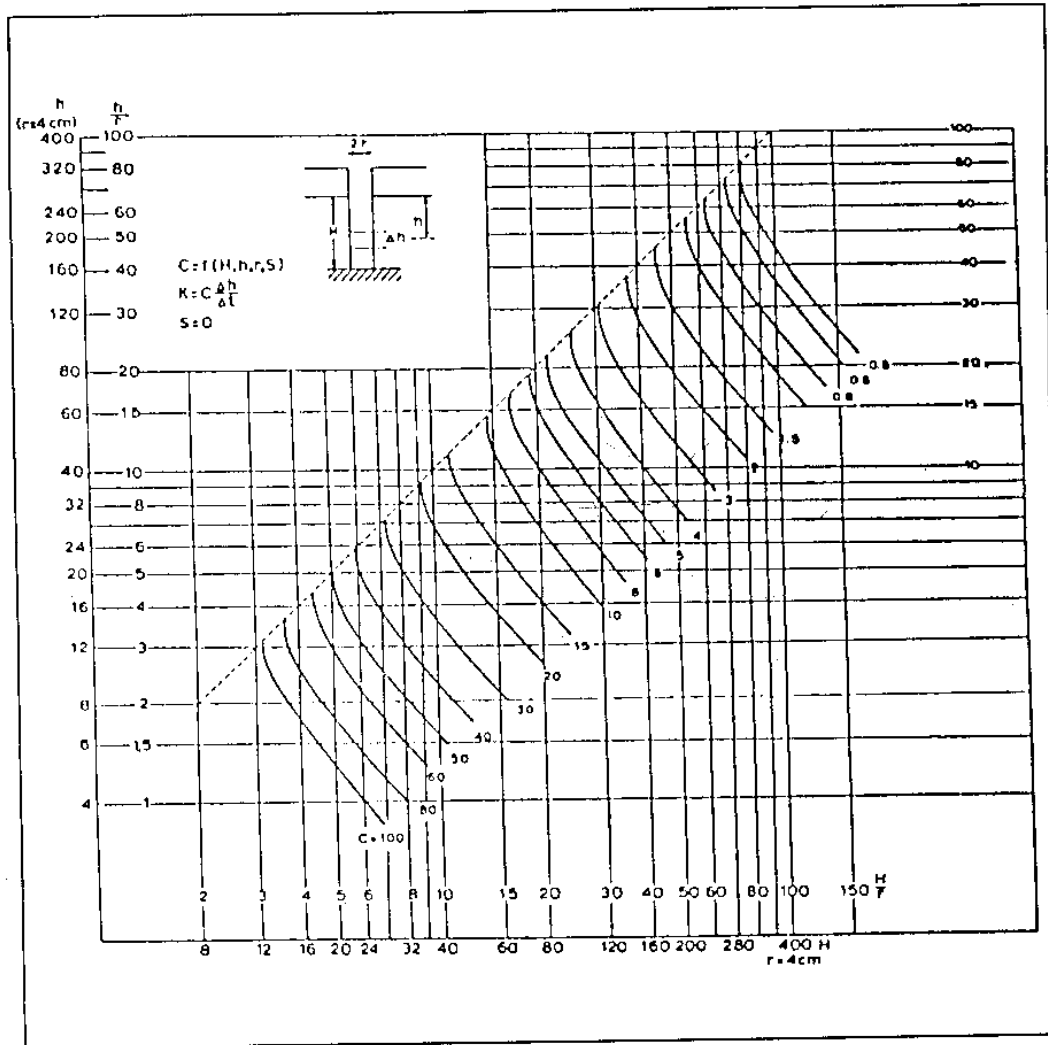

Figure 2.3: Nomograph for determination of C in Auger-Hole method for $S=0$ (Ernst, 1950).

Computation of K_s by Hooghoudt's method

i. The Hooghoudt's method in the case where the auger hole does not reach to the impervious layer, is given by;

$$K_s = \frac{4000 r^2}{h(H+2Gr) \left[2 - \frac{h}{H} \right]} \frac{\Delta h}{\Delta t} \quad (2.2)$$

where,

- h = Mean depth of water level in the hole = $h(t_0) - 0.5\Delta h$,
 $\Delta h/\Delta t$ = Mean rate of rise of the water level in the bore hole,
 K_s = Saturated hydraulic conductivity expressed in metre/day.

All the other quantities are in cm or in sec.

ii. If the hole reaches the impermeable layer K_s is computed from ;

$$K_s = \frac{3600 r^2}{h(H+1.0r) \left[2 - \frac{h}{H} \right]} \frac{\Delta h}{\Delta t} \quad (2.3)$$

This method is applied only for the following conditions:

- $3 < r < 7$ cm
 $S > 0.5H$
 $20 < H < 200$ cm
 $h > 0.2H$

For practical cases it must be noted that it is advisable to determine hydraulic conductivity in bore holes at different depths when different layers have been observed.

2.2.1.2 Guelph Permeameter method

The auger hole method is a simple reliable technique for measuring saturated hydraulic conductivity in relatively uniform soils below the water table. However, this method can not be used if the water table is not present in the region of interest. The methods for measuring hydraulic conductivity in the absence of the water table are more complicated. Guelph Permeameter is a constant head well permeameter (also known as dry auger hole method) may be used in such situations. The details of Guelph Permeameter and the method of determination employed in the present study has been explained in Chapter 4.

2.2.2 Direct Method (Using laboratory techniques)

Laboratory measurements of hydraulic conductivity are conducted on soil samples contained in cylinder of known dimensions. If the hydraulic conductivity values are to be representative of a soil in situ, undisturbed soil samples are to be obtained. Stainless steel cylinder with a thin wall and one sharpened end are used to extract soil samples above the groundwater table (Kopecky rings of 50 mm diameter, 51 mm length with thickness 1.5 mm). They are pressed gradually and evenly into the face of a profile pit. Care is taken to minimise soil compaction. The soil around the cylinder is then removed and the cylinder containing the soil sample is withdrawn. The end of the sample should not be cut with a knife but should be removed to expose the natural structure of the soil. Undisturbed samples below unsaturated zone can be obtained by using a coring apparatus and driven into the soil at the bottom of the bore hole. Closing of the tube above and below the sample by inflatable rubber rings prevents the loss of material during extraction. The sample can only be taken in vertical direction. The saturated hydraulic conductivity is then determined using ICW Permeameter.

2.2.2.1 Construction of a ringholder

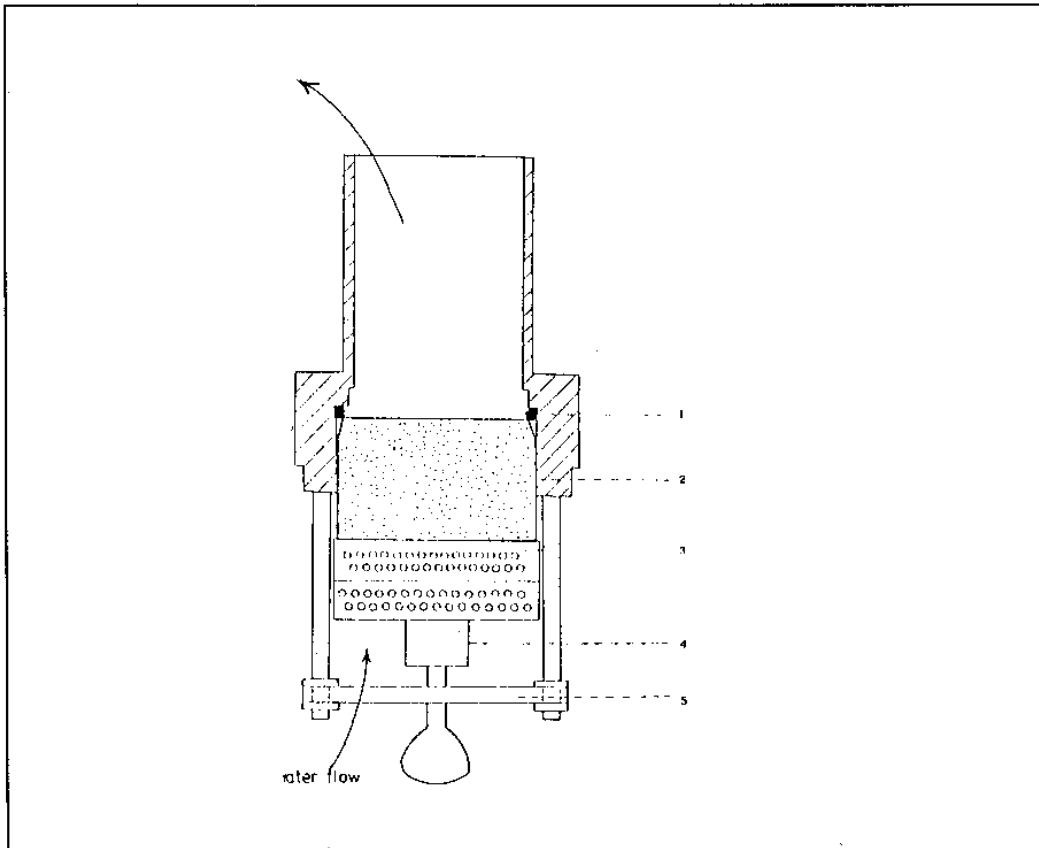

Figure 2.4: Parts of a Ring Holder.

The first requirement is a soil core that has been collected in Kopecky rings from field. as given in figure, a double strainer cap(3) is fixed to the blunt side of ring(2). The cutting edge of the ring is placed against (exchangeable) O-ring(1). Then bridge(5) is closed and the nylon pressing block(4) is tightened so as to press the ring firmly against the O-ring. The ring holder is now placed in the special container of the ICW permeameter that maintain the constant water level. It is kept there for saturation for two to three days depending on the soil type, saturated hydraulic conductivity is then measured by following principles listed below:

2.2.2.2 Principles of I C W Permeameter

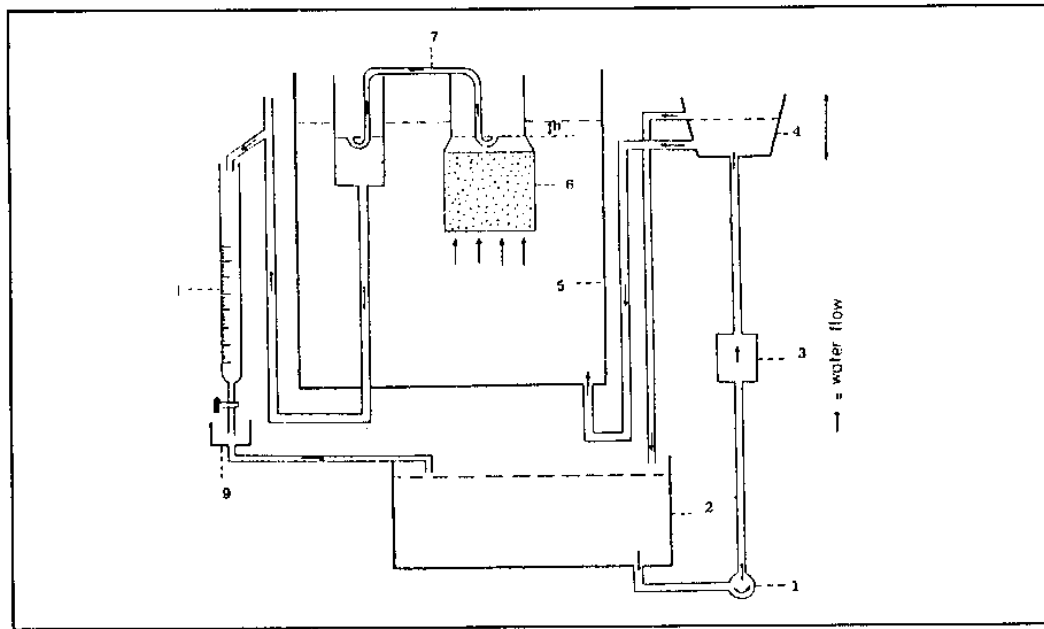

Figure 2.5: Working principle of ICW Laboratory Permeameter.

I C W Permeameter (Figure 2.5) works in the following way. A circulation pump(1) raises water from the storage cistern(2) via filter(3), to the adjustable level regulator(4). To this regulator other two pipes are connected, one leads to plastic container(5), and the other takes the surplus water back to the storage cistern. The regulator will keep the desired water level in the container. The saturated soil sample in ring(6) is then placed into a special ringholder, which in turn is placed inside the container. Siphon(7) will lead the water oozing out through the sample via burette(8) and leak basin(9). Thus, due to head difference a continuous water flow takes place. The rate of flow is measured.

2.2.2.3 *Constant head method*

This is applicable for light textured soil which is medium to highly permeable. The following formula is used for determination of hydraulic conductivity.

$$K_s = 144 \left[\frac{QL}{hA_1} \right] \quad (2.4)$$

where,

- K_s = Saturated hydraulic conductivity, in m/day,
- Q = Discharge collected in the burette, in cc/min,
- L = Length of the soil core, in cm = 5.0 cm,
- h = Head difference, in mm,
- A_1 = Cross sectional area of soil core, in cm^2 .

2.2.2.4 Falling head method

This method is applied to clayey soil or heavy textured soil. The main difference with the constant head method lies in the fact that the quantity of water that flows away from the sample is not measured. The rise of water ($h_1 - h_2$) above the sample in time ($t_2 - t_1$) is noted. A certain amount of water will evaporate from the ring holder. Correction factor for the same is incorporated in the formula.

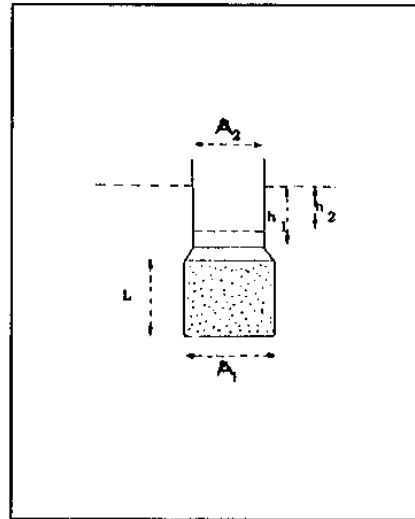

Figure 2.6: Reading by Falling Head method.

$$K_s = 0.24 \frac{A_2 L}{A_1 (t_2 - t_1)} \ln \left[\frac{h_1}{h_2} \right] + 0.00864 \frac{A_2 L}{A_1 \sqrt{h_1 h_2}} \quad (2.5)$$

where,

- K_s = Saturated hydraulic conductivity, in m/day,
- A_1 = Cross sectional area of soil core, in cm^2 ,
- A_2 = Cross sectional area of the ringholder, in cm^2 ,
- L = Length of the soil core, in $\text{cm} = 5.0 \text{ cm}$,
- $h_1 - h_2$ = Head difference, in mm ,
- $t_2 - t_1$ = Time interval from t_1 to t_2 , in hrs.

$$0.00864 \frac{A_2 L}{A_1 \sqrt{h_1 h_2}} \text{ - Correction factor for evaporation.}$$

2.2.3 Indirect Method for Estimation of Hydraulic Conductivity

Information on other soil properties is often readily available or simpler to determine. Methods have been developed to estimate hydraulic conductivity from related soil properties, such as soil texture, porosity and bulk density etc. In Chapter 4 estimation procedures for soil suction, the soil water content and hydraulic conductivity have been described.

3.0 STUDY AREA

Soils of central Bihar are mainly alluvial brought by river. The alluvium represents the vast tract of Gangetic plain. The main characteristics of this soil is the high content of calcium carbonate. These soils are light coloured and their texture varies from sandy loam to loam.

The area selected is an agricultural field situated in the WALMI Complex of Phulwari Sharif, Patna. It is about 5 km away from the right bank of river Ganga. The study area contributes to a part of central Bihar which lies in 85°E longitude and 25.5°N latitude.

3.1 Soil Type

Predominantly, the soils are of Gangetic alluvium containing high percentage of silts. Alluvial soils represent the vast tract of riverine alluvium of the Gangetic Plains, with a width of about 320 km. The topography is plain with gentle slope of about 0.1 %. The soil colour ranges from pale grey to yellow brown, and dark grey.

The alluvial soils are of two types, namely:

- i. Young alluvial soil : Lies in North Bihar especially available in between Ghagra and Gandak, Gandak and Buri-Gandak, and Sone and Punpun. Moreover the river banks and its nearby areas along the river system are composed of young alluvium. This is a baby soil (Entisol) occupying a lower elevation and contains particular bed of sand, gravel and peat.
- ii. Older Alluvium soil: The alluvium deposits are with a massive bed of clay either sandy or calcareous. They generally occupy elevated terraces formed by the segregation of calcareous materials into lumps and nodules. They are dark ash in colour.

Soils of the study area is of new alluvium.

4.0 MATERIAL AND METHODS

4.1 Direct Measurement by Guelph Permeameter

The Guelph permeameter is an in hole permeameter, employing the Mariotte principle. Constant hydraulic head in the well is established and maintained by regulating the bottom of air tube. Whenever water level in the well begins to drop in the air inlet tip, air bubbles emerge from the tip and rise into the reservoir air space. Water from the reservoir replenishes water into the well. Falling rate of water from the reservoir to the well is measured. Gradually, when equilibrium is established, the rate of fall of water from the reservoir become constant. In this equilibrium condition around the well, a bulb of saturated soil of specific dimension is established which ensures reaching of outflow of water from soil to a steady state flow rate. At this stage, the rate of falling of water from reservoir is noted. The rate of this constant outflow of water together with the diameter of well and height of water in the well can be used to determine the Field saturated hydraulic conductivity, Matric flux potential and Sorptivity of the soil.

The method involves measuring the steady state rate of water discharged from a small open cylindrical hole (well) of radius a (2-5cm) above the water table, in which a constant depth of water H is maintained. A simple in-hole mariotte bottle arrangement is used to maintain H and to measure corresponding flux Q , field saturated hydraulic conductivity K_{fs} , sorptivity S , matrix flux potential Φ_m and a constant α relating to soil water potential. Unsaturated hydraulic conductivity are then calculated from Q , H and a , using Richard's analysis based on steady state solutions for infiltration into unsaturated soils from a well (Reynolds and Elrick, 1985).

Renolds and Elrick (1985) described steady state flow from cylindrical well to unsaturated soil as:

$$2\pi H^2 K_{fs} + C\pi a^2 K_{fs} + 2\pi H\Phi_m = CQ \quad (4.1)$$

where,

- Φ_m = matrix flux potential ($m^2 s^{-1}$)
- C = dimensionless proportionality parameter.

The first term of the equation represents the **hydraulic push** of the liquid in the well, the second term the **gravitational pull** of liquid out through the bottom of the well, and the

third term represents the **matrix pull** of the liquid out of the well due to capillary forces in the surrounding soil.

The first two terms of the equation may be thought as of the **field saturated** component of flow out of the well, and the third as the unsaturated flow component.

The matrix flux potential, Φ_m , has been defined by Gardner (1958) as,

$$\Phi_m = \int_{\psi_1}^0 K(\psi) d\psi \quad -\infty < \psi_1 < 0 \quad (4.2)$$

where,

$K(\psi)$ = is the hydraulic conductivity-pressure head relationship for infiltration and ψ_1 is considered uniform in the vicinity of well.

4.1.1 Computation of K_{fs} , Φ_m , S , α and $K(\psi)$

4.1.1.1 Field saturated hydraulic conductivity (K_{fs})

$$K_{fs} = G_2 Q_2 - G_1 Q_1 \quad (4.3)$$

where,

$$G_2 = \frac{H_1 C_2}{\pi [2H_1 H_2 (H_2 - H_1) + \alpha^2 (H_1 C_2 - H_2 C_1)]}$$

$$Q_2 = (X)(R_2) \quad \text{OR} \quad (Y)(R_2)$$

$$G_1 = G_2 \frac{H_2 C_1}{H_1 C_2}$$

$$Q_1 = (X)(R_1) \quad \text{OR} \quad (Y)(R_1)$$

- K_{fs} : field saturated hydraulic conductivity, in cm/sec.
- H_1, H_2 : well height for first and second measurements respectively in cms.
- C_1, C_2 : C factors corresponding to H_1/a and H_2/a respectively,
- a : well radius in cms,
- C : proportionality factor dependent primarily on the H/a ratio,
- R_1, R_2 : steady state rate of fall corresponding to H_1 and H_2 respectively and converted to cm/sec.
- X : Reservoir constant when both inner and outer reservoirs are used,
- Y : Reservoir constant when only inner reservoir is used.

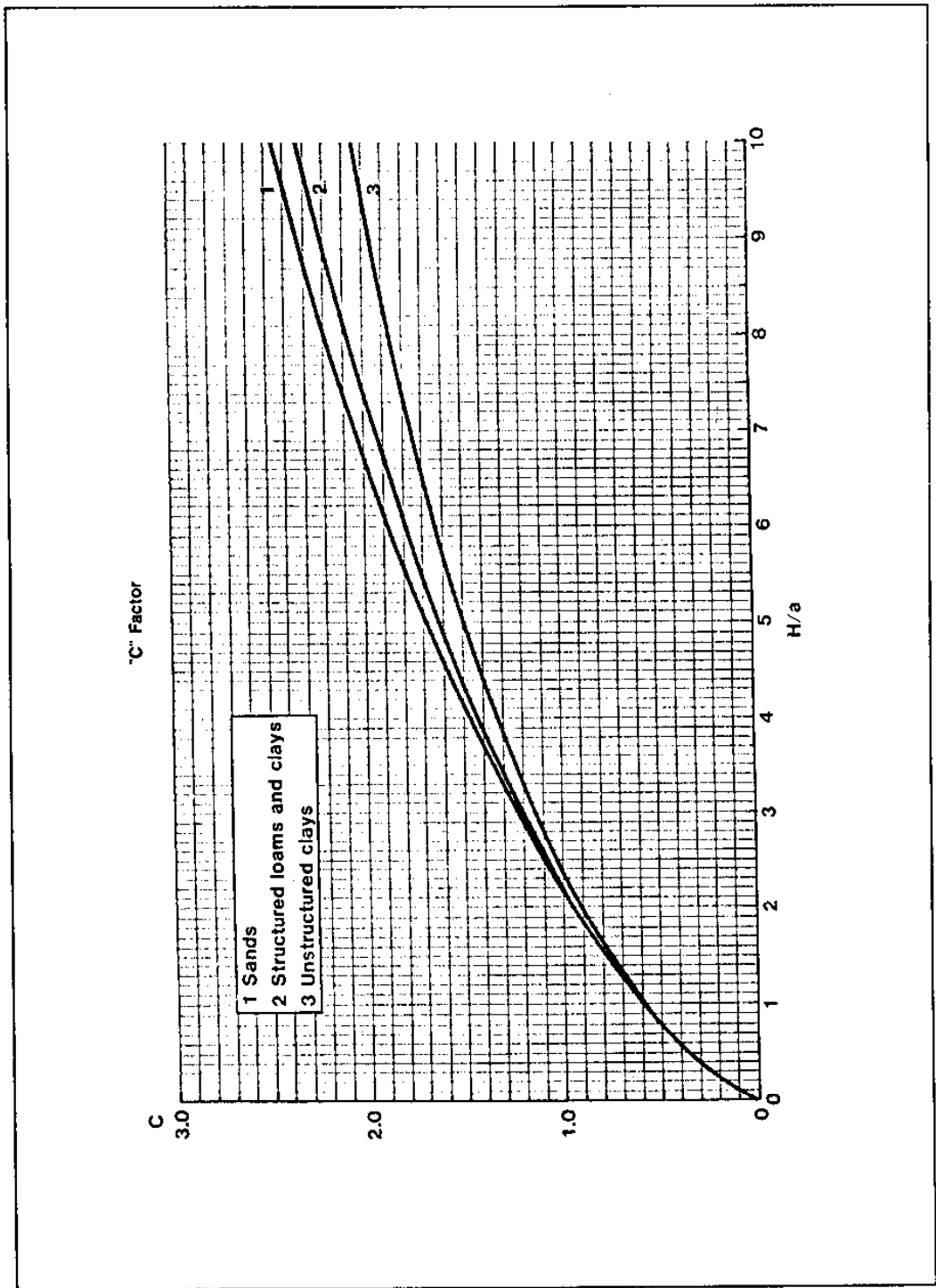

Figure 4.1: Standard curve for 'C' factor.

4.1.1.2 Matrix flux potential (Φ_m)

$$\Phi_m = J_1 Q_1 - J_2 Q_2 \quad (4.4)$$

where,

$$J_1 = \frac{(2H_2^2 + a^2 C_2) C_1}{2\pi [2H_1 H_2 (H_2 - H_1) + a^2 (H_1 C_2 - H_2 C_1)]}$$

$$J_2 = J_1 \frac{[(2H_1^2 + a^2 C_1) C_2]}{[(2H_2^2 + a^2 C_2) C_1]}$$

4.1.1.3 Sorptivity (S)

Soil sorptivity is calculated from the following equation (Philip, 1973).

$$S = \sqrt{2 \Delta \theta} \Phi_m \quad (4.5)$$

where,

$$\Delta \theta = (\theta_{fs} - \theta_i) \text{ i.e the change in the water content in the soil adjacent to the well from the initial value } \theta_i \text{ to the field saturated value } \theta_{fs}.$$

4.1.1.4 Alfa constant (α)

Alpha is a measure of the soil's ability to absorb water. It is a constant which is dependent on the porous properties of soil and is calculated as follows:

$$\alpha = \frac{K_{fs}}{\Phi_m} \quad (4.6)$$

The larger the ratio, the smaller the absorptive ability or capillarity.

4.1.1.5 Conductivity-Pressure Head relationship $K(\psi)$

The hydraulic conductivity/pressure head relationship, $K(\psi)$ describes the change in unsaturated hydraulic conductivity K with soil suction. Generally, as soil suction increases, hydraulic conductivity decreases exponentially. For any soil suction, the hydraulic conductivity can be predicted by the following equation:

$$K(\psi) = K_{fs} e^{\alpha \psi}$$

where,

$$\psi = \text{soil water suction in cms of water.}$$

4.1.2 Operation of Guelph Permeameter

Before making measurement by Guelph permeameter (Figure 4.2) in the field, it is necessary to perform the following functions:

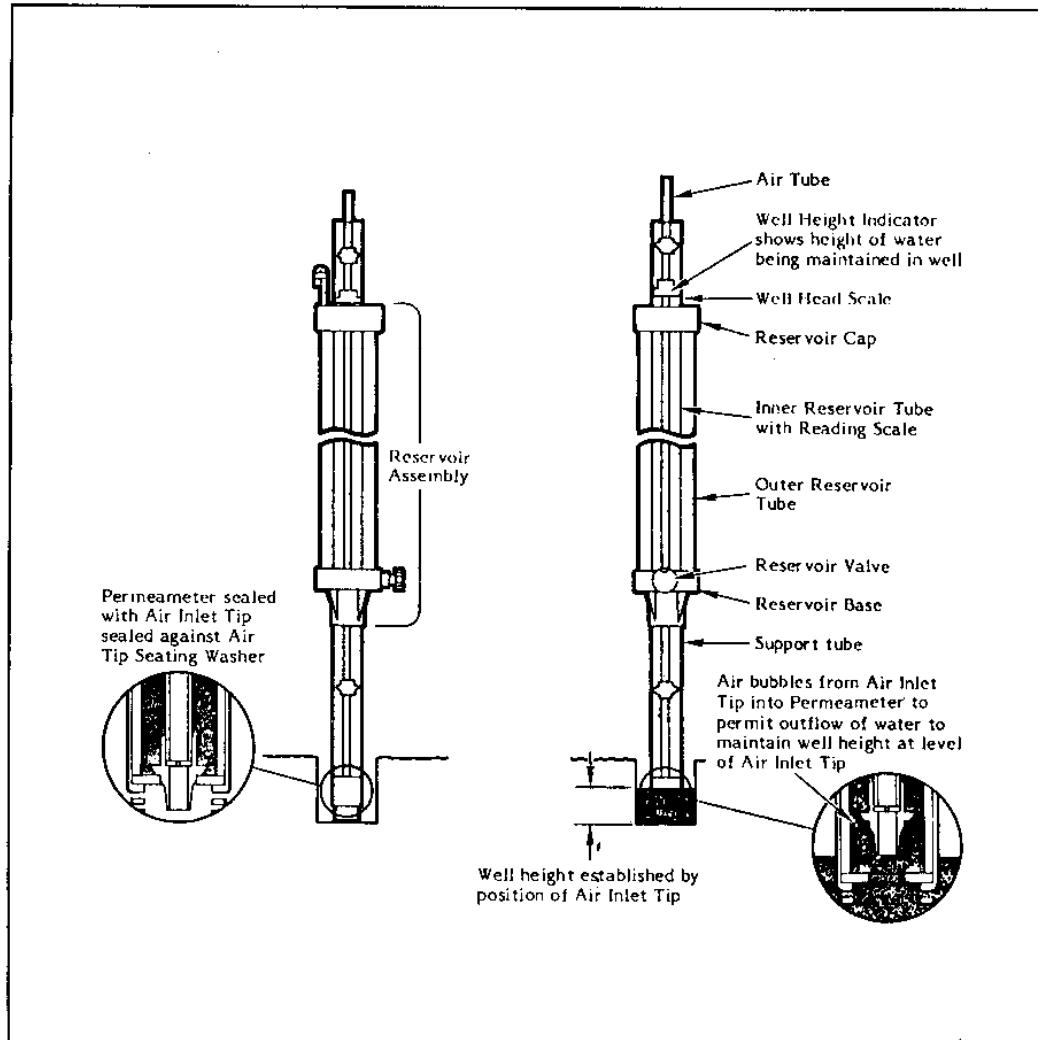

Figure 4.2: Different parts of a Guelph Permeameter.

4.1.2.1 Well preparation

The soil auger is used to excavate a bore hole and to remove bulk amount of soil. The sizing auger of 6 cm diameter is used to clean debris from the bottom of the well hole. Generally, the procedure is to use the soil auger to excavate the well hole of 15 cm less than the desired depth. The last 15 cm then can be excavated using the sizing auger to produce debris free well hole of uniform geometry.

In moist soils or in medium to fine textured soils, the process of augering a hole may create a smear layer which can block the natural flow of water from the well into the surrounding soil. The well preparation brush is designed to use in the standard 6 cm diameter well hole to remove the smearing.

4.1.2.2 Permeameter placement

Centre the tripod over the well hole and slowly lower the permeameter so that the support tube enters the well hole. The tripod is used to support the permeameter in well, down to approximately 38 cms in depth. For use in wells deeper than 38 cm, the tripod busing alone provides the function of centring and stabilising the permeameter as shown in Figure 4.3. After the permeameter is placed, it can easily be filled with water. The following standard procedure should be followed.

i. Verify that both the reservoirs are connected. The reservoirs are connected when the notch on the reservoir valve is pointing up.

ii. Establish 5 cm well head height (H_1) by raising the air inlet tip to a height (H_1). Raising the air tube too quickly can cause turbulence and erosion in the well.

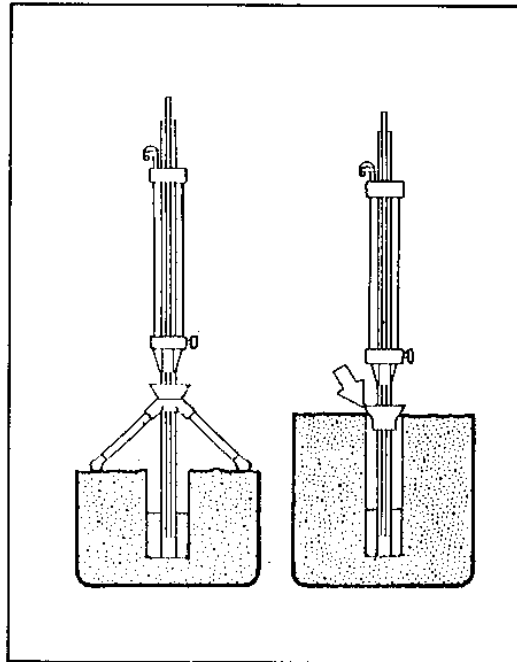

Figure 4.3: Permeameter placement.

- iii. Observe the rate of fall of the water level in the reservoir. If it is too slow, then turn the reservoir valve so that the notch is pointing down. Under this situation water from the inner reservoir will be supplied resulting in a much greater drop in water level between readings.
- iv. Measure permeameter outflow. This is indicated by the rate of fall of water in the reservoir. Readings should be made at a regular time interval, usually 2 minute intervals are used. The difference of readings at consecutive interval divided by the time interval equals the rate of fall of water(R), in the reservoir. Continue monitoring the rate of fall of water until the rate of fall becomes steady. This steady rate is called R₁, and is defined as the "steady state rate of fall" of water in the reservoir at height H₁.
- v. Establish 10 cm well head height (H₂) by raising the air inlet tip to a height of 10 cm. Monitor the rate of fall of water R₂, in the reservoir until a steady value of R₂ is measured.
- vi. The field saturated hydraulic conductivity K_{fs} can be calculated using the following equation

$$K_{fs} = (0.0041)(X)(R_2) - (0.0054)(X)(R_1) \quad (4.8)$$

or

$$K_{fs} = (0.0041)(Y)(R_2) - (0.0054)(Y)(R_1) \quad (4.9)$$

where,

- K_{fs} = Field saturated hydraulic conductivity (cm/sec).
- X = Reservoir constant, equals to 35.47 when reservoir combination is used.
- Y = Reservoir constant, equals to 2.14 when only inner reservoir is used.
- R₂ = Steady rate of fall of water in the reservoir when second head H₂ equals to 10 cm is established.
- R₁ = Steady rate of fall of water in the reservoir when the first head equals to 5 cm is established.

(Note: The constants X and Y are inscribed on the notch of the instrument. It varies from one instrument to other)

4.2 Indirect Method through Soil Properties

4.2.1 Collection of soil samples

Two types of soil samples are collected from the field by soil auger.

- i. **Disturbed soil sample:** Samples are taken from a desired depth. If it is found different in colour, texture and structure, sample from each layer is taken. Otherwise, about 500gm samples are generally taken and kept in polythene bags from three different depths at 50, 100 and 150 cm in the same location or nearby within a radius of one metre. These samples are used to determine the initial moisture content and analysis for percentage of sand, silt and clay.
- ii. **Undisturbed soil sample :** Soil core of the respective location and depths are also taken by using core cutter. First, a hole is made by auger. Augering is stopped at 5 cm before it reaches the desired depth from which soil core is to be taken. The core cutter is now used. It has an attachment to hold the soil core ring. The assembly is lowered into the hole and hammered for 5 cm depth. The soil core, so obtained is with minimum disturbances. The core can be used to determine the bulk density and subsequently for ICW laboratory permeameter to determine hydraulic conductivity.

4.2.2 Determination of initial Moisture content and Bulk density

The soil core is weighed immediately in the laboratory on return from field so that no moisture is lost. The same core is put in the oven and dried for 24 hrs at 105°C and weighed. The difference in mass divided by the dry mass gives the moisture content on dry basis.

The dry mass of the core divided by the total volume of the core gives the bulk density. Behaviour of soil is dependent on the bulk density of the soil profile. Average bulk density of clay is 1.1 whereas the same for sand is 1.6 gm/cc.

The density of soil particle, called particle density, is defined as the mass of dry soil divided by the volume of solids which is assumed to 2.65 gm/cc, and need not be measured.

Porosity is defined as volume of voids divided by total volume of soil. This is again related with bulk density and particle density as per the following formula.

Porosity = 1 - (bulk density / particle density)
(the value being 0.2 to 0.6 from coarse to fine textured soil)

4.2.3 Removal of Carbonates, Organic matter, Iron oxides and soluble salts

The soil sample may contain carbonates, organic matters and iron oxides. It is a prerequisite to remove these compounds before sieving. It is done by applying the following methods:

i. **Removal of Carbonates**

- 200 gm soil sample is taken in a 500 ml beaker. Add 30 ml deionised water and stir for some time.
- 10% HCl is added slowly until effervescence stops.
- Samples are then heated to 80-90°C. More HCl is added until effervescence stops.
- After heating, samples are washed by deionised water two to three times.

ii. **Removal of organic matter**

A little quantity of organic matter is present in the soil sample. The sample is placed in a 500 ml beaker. Slowly add with 100 ml of 6% hydrogen peroxide and stir continuously. The sample is then covered and heated to 40°C for 1 hour. The sample is then boiled for a short period to remove the excess hydrogen peroxide.

iii. **Removal of Iron Oxide**

Sample is placed in a 500 ml beaker and water is added to make a volume of about 350 ml. An aluminium sheet is placed into the beaker. About 25 gms of oxalic acid is added and is boiled gently for 10 to 20 minutes.

iv. **Removal of soluble salts**

The sample is washed for 3 to 4 times by deionized water after removing carbonates, organic matter, and iron oxide. The salts present in the sample are thus removed.

v. **Drying and weighing**

Sample is dried at 40°C in oven and weighed to nearest .001 gm.

4.2.4 Separation of fractions to be sieved

Sieving can be done mechanically, crushing the soil sample, and simply sieve the known quantity of dry soil by a set of ASTM sieves having mesh No 4, 10, 14, 20, 40, 60, 70, and 200 corresponding to equivalent diameter 4.75, 2.00, 1.40, 0.825, 0.425, 0.250, 0.212, and 0.075 mm respectively. This method of dry sieving is not accurate as clay and silt particles are difficult to separate from the soil granules.

The fraction to be sieved is separated by wet sieving. For this purpose take 100 gm of dried sample in a 500 ml beaker. Add deionised water and some dispersing agent (sodium hexa-meta-phosphate) and keep the solution for 5 to 6 hours to disperse the sample. After dispersion the sample is stirred and passed through .075 mm sieve and washed so that all the grains smaller than .075 mm diameter passes through the sieve and collected in a 1000 ml cylinder for separation of silt and clay. Sample left on the sieve is oven dried at 105°C and kept for dry sieving.

4.2.5 Particle size distribution by master sizer

Well dispersed soil sample containing silt and clay (about 20 ml) is taken in a beaker. The sample chamber and sensors are thoroughly cleaned using distilled water. Fill the chamber with 1 litre of distilled water. Add 3 to 4 spoons (10 ml) of soil solution and run the machine. The sensors, sense the diameter of the soil particles, 5000 times in a single run and gives the percentage of average diameter of different particle sizes. It also gives S-curve depicting particle diameter on X-axis v/s percentage finer on y-axis. The percentage finer than 0.002 mm is considered as clay. This is converted to equivalent percentage of sand, silt, and clay of the original quantity of sample taken.

4.2.6 Classification of soil by soil texture triangle

Particles size limits may be classified according to several current classification schemes. There are four schemes namely,

USDA	:	U.S.Department of Agriculture
CSSC	:	Canadian Soil Survey Committee
ISSS	:	International Soil Science Society
ASTM	:	American Society for Testing and Materials

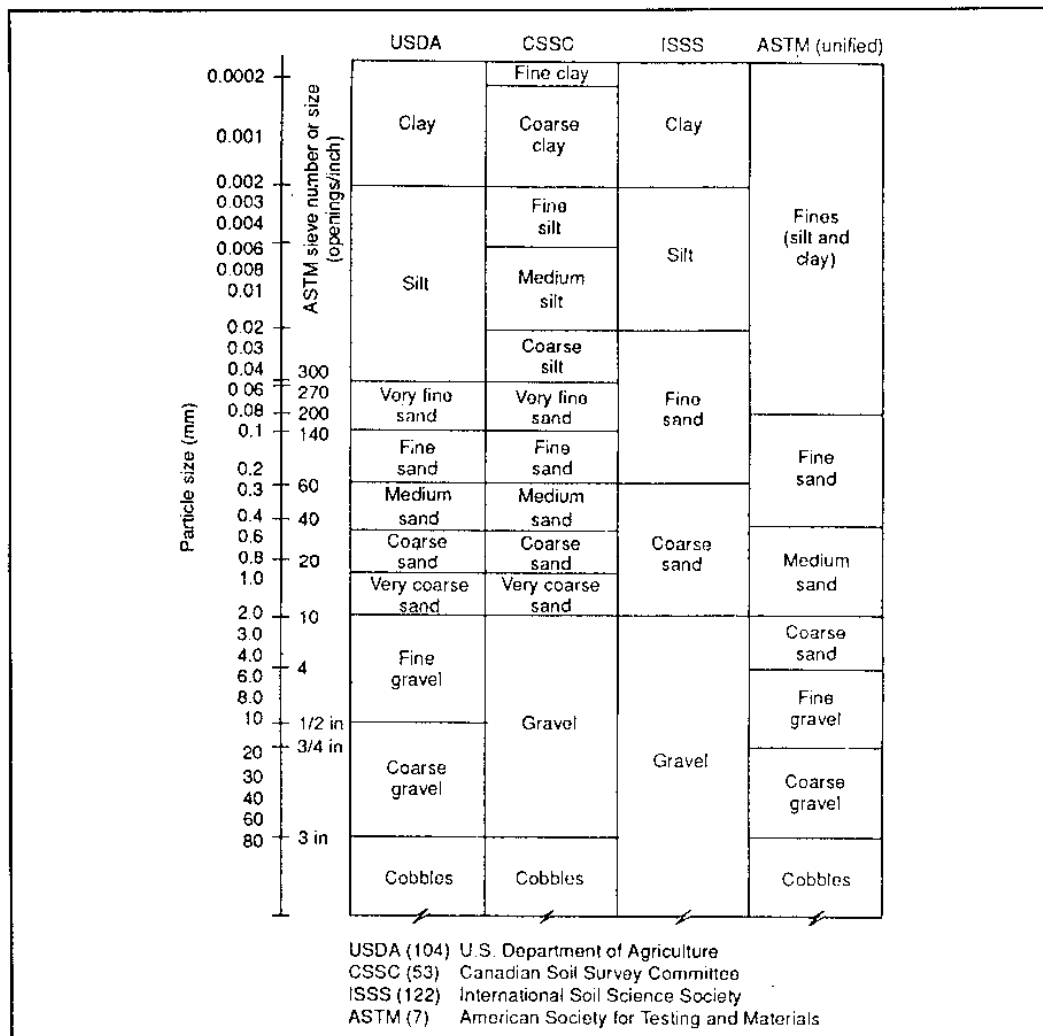

Figure 4.4: Particle size distribution ranges for various classification.
 (Source: Dravid, R. Maidment, 1992. Handbook of Hydrology, pp-5.3)

Here, ASTM classification was followed to determine percentage of sand, silt, and clay. After determining the sand percentage by sieve analysis, the soil particles retained on the pan (dia less than 0.075 mm) was analyzed by using "MASTRESIZER" for silt and clay. Once the percentage of sand, silt, and clay is known, soil texture triangle (Figure 4.5) can be used to classify the soil texture.

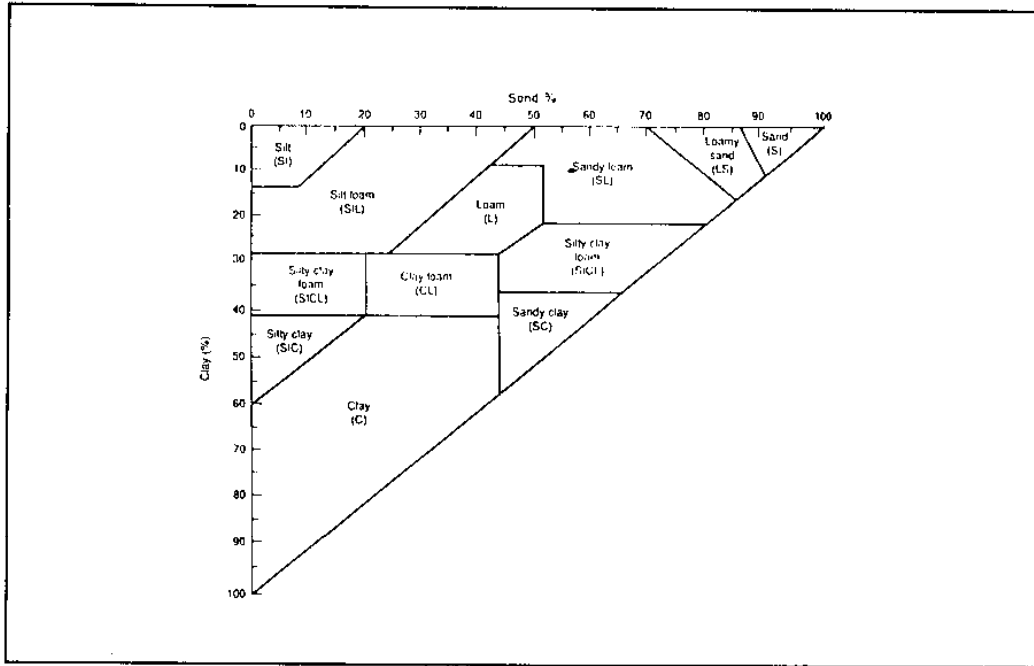

Figure 4.5: Soil texture triangle.

4.2.7 Estimation of soil water suction

Indirectly the soil water suction can be estimated. Rawls and Brakensiek modified the Green-Ampt wetting front suction parameter to soil properties in the following equation (David, R. Maidment, 1992):

$$S_f = \exp[6.53 - 7.326(\phi) + 0.00158(C^2) + 3.809(\phi^2) + 0.000344(S)(C) - 0.04989(S)(\phi) + 0.0016(S^2)(\phi^2) + 0.0016(C^2)(\phi^2) - 0.0000136(S^2)(C) - 0.00348(C^2)(\phi) + 0.000799(S^2)(\phi)] \dots \dots \dots (4.10)$$

Where,

- S_f = Soil water suction (cm),
- ϕ = Porosity in fraction,
- C = Percent clay,
- S = Percent sand.

4.2.8 Estimation of water content

With the known soil type and suction - the volumetric water content can be found out from standard curves (Figure 4.6). (David, R.Maidment, 1992).

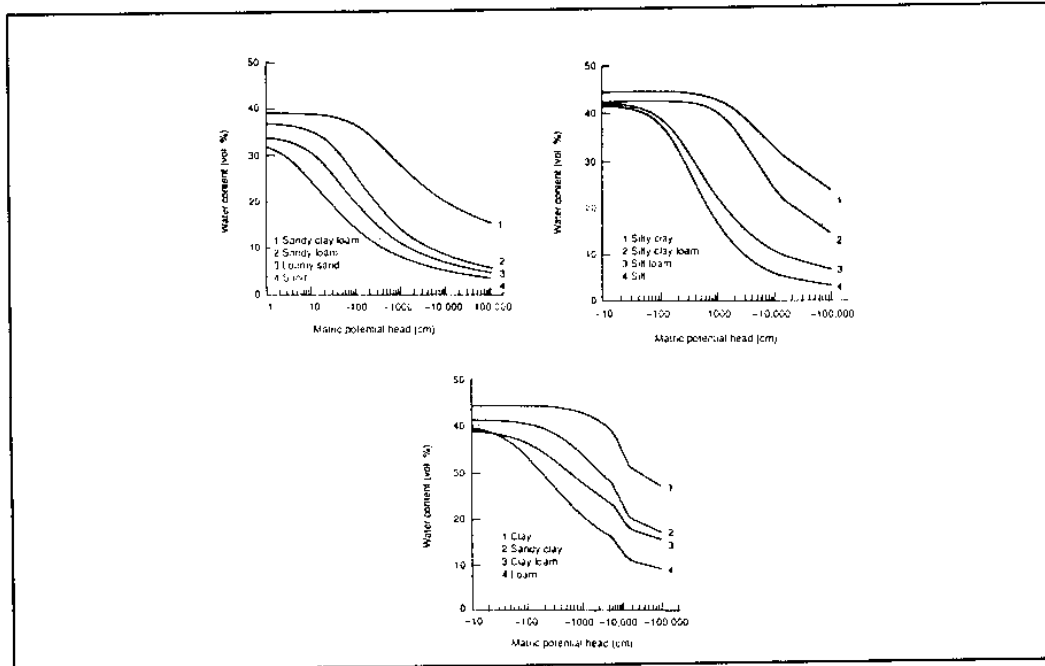

Figure 4.6: Water retention curves for USDA soil textures.

4.2.9 Estimation of saturated hydraulic conductivity

i. Indirect methods are available to estimate the hydraulic conductivity. Saturated conductivity in the plants root zone seldom occurs. Therefore it is essential to know the unsaturated K. When the water content of the soil falls below saturation-suction or negative pressure develops. After draining out the water from pores by virtue of gravity, water is held inside the soil at field capacity (-33 KPa). Plant roots exert pressure to uptake water at this stage resulting in upward capillary movement through soil.

If only soil texture classes are available, the saturated hydraulic conductivity can be found out (Figure 4.7). Knowing the degree of saturation the corresponding unsaturated hydraulic conductivity may be estimated (Figure 4.8).

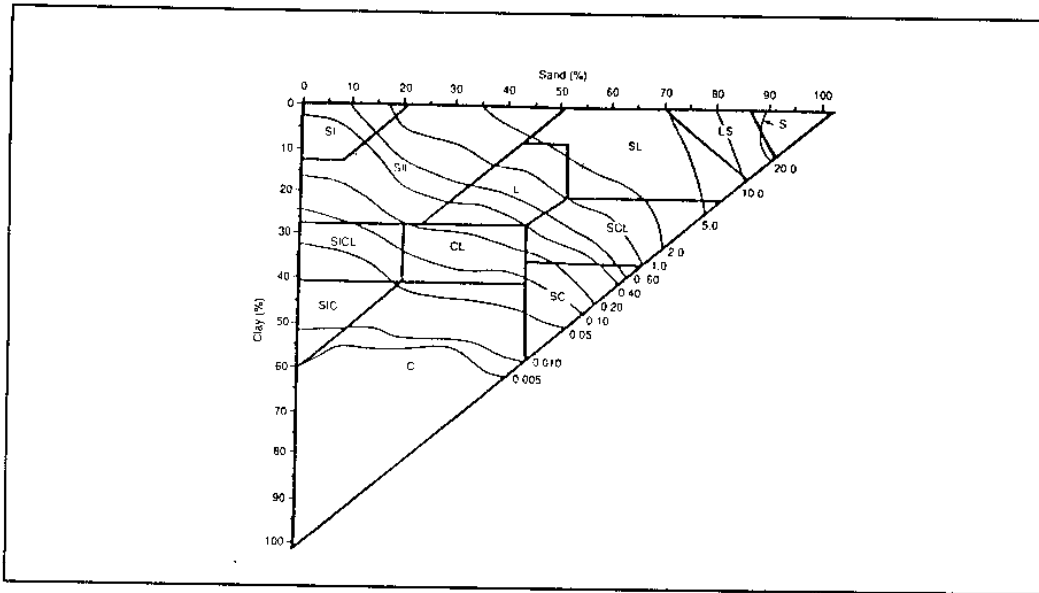

Figure 4.7: Saturated hydraulic conductivity sorted by USDA soil triangle.

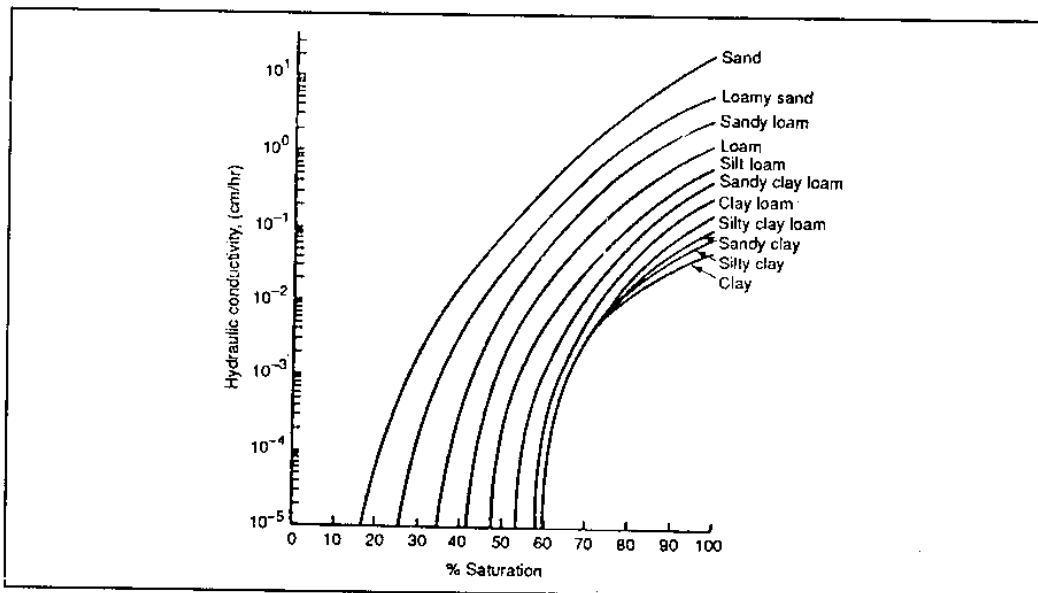

Figure 4.8: Hydraulic conductivity sorted by soil texture.

ii. Another technique which is more specific is developed by Ahuja et al. It relates the saturated hydraulic conductivity to the effective porosity (total porosity obtained from soil bulk density minus the soil water content at -33 KPa matric potential). Saturated hydraulic conductivity is found by Kozeny-Carman equation.

$$K_s = B(\phi_e)^n \quad (4.11)$$

where,

- K_s = Saturated hydraulic conductivity (cm/hr),
- B = coefficient, equals 1058,
- ϕ_e = effective porosity,
- n = 4.

The following table can be used to refer the average water content at -33 K Pascal as per soil textural classes.

Table 4.1: Water retention properties classified by soil texture.

Sl	Texture Class	Sample Size	Total Porosity	Water Retained at	
				- 33 KPa	- 1500 KPa
1.	Sand	762	0.437 (0.374-0.500)	0.091 (0.018-0.164)	0.033 (0.007-0.059)
2.	Loamy sand	338	0.437 (0.368-0.506)	0.125 (0.060-0.190)	0.055 (0.019-0.091)
3.	Sandy loam	666	0.453 (0.351-0.555)	0.207 (0.126-0.288)	0.095 (0.031-0.159)
4.	Loam	383	0.463 (0.375-0.551)	0.270 (0.195-0.345)	0.117 (0.069-0.165)
5.	Silty loam	1206	0.501 (0.420-0.582)	0.330 (0.258-0.402)	0.133 (0.078-0.188)
6.	Sandy clay loam	498	0.398 (0.332-0.464)	0.255 (0.186-0.324)	0.148 (0.085-0.211)
7.	Clay loam	366	0.464 (0.409-0.519)	0.318 (0.250-0.386)	0.197 (0.115-0.279)
8.	Silty clay loam	689	0.471 (0.418-0.524)	0.366 (0.304-0.428)	0.208 (0.138-0.278)

Sl	Texture Class	Sample Size	Total Porosity	Water Retained at	
				- 33 KPa .	- 1500 KPa
9.	Sandy clay	45	0.430 (0.370-0.490)	0.339 (0.245-0.433)	0.239 (0.162-0.316)
10	Silty clay	127	0.479 (0.425-0.533)	0.387 (0.332-0.442)	0.250 (0.193-0.307)
11	Clay	291	0.475 (0.427-0.523)	0.396 (0.326-0.466)	0.272 (0.208-0.336)

First line is the mean value. Second line is \pm one standard deviation about the mean.
(Source; Dravid,R.Maidment.1992.Handbook of Hydrology,p- 5.15)

4.2.10 Estimation of unsaturated hydraulic conductivity

Unsaturated flow in the zone of aeration can be analyzed by Darcy's law. Hydraulic conductivity for unsaturated soil is a function of water content or the negative pressure head. Because part of the pore space is filled with air, the cross section area available for water flow is reduced. As a result, unsaturated K is always less than the conductivity of saturated soil.

Although there is hysteresis effects present in the relation of unsaturated K with water content and negative pressure, approximation based on empirical relation can be stated. Irmay (1954) states the following relation based on water content.

$$\frac{K}{K_s} = \left[\frac{S - S_o}{1 - S_o} \right]^3 \quad (4.12)$$

Where,

- K = Unsaturated hydraulic conductivity,
- K_s = Saturated hydraulic conductivity,
- S = Degree of saturation,
- S_o = Threshold saturation(=0.2), the saturation corresponding to that part of the voids filled with non moving water held primarily by capillary forces. Note that K ranges from zero at $S = S_o$ to K_s at $S = 1$.

5.0 RESULTS AND DISCUSSIONS

The soil core obtained from the field was dried to 105°C and weighed. The core dimension was 5cm in diameter and 5cm in height. The volume of the core was 98.125 cc. Bulk density was determined and listed in (Table 5.1).

Table 5.1: Calculation of Bulk Density.

Sl.	Sample No.	Soil Texture	Dry Weight(g)	Volume (cc)	Dry Bulk Density(g/cc)
1	SN 2/1/50	Sandy loam	149.150	98.125	1.52
2	SN 2/1/100	Loamy sand	165.831	98.125	1.69
3	SN 2/1/150	Sandy loam	146.206	98.125	1.49
4	SN 2/2/50	Silty loam	137.375	98.125	1.40
5	SN 2/2/100	Silty loam	136.394	98.125	1.39
6	SN 6/1/50	Sandy loam	145.225	98.125	1.48
7	SN 6/1/100	Sandy loam	152.094	98.125	1.55
8	SN 6/1/150	Sandy loam	159.944	98.125	1.63
9	NIH 1/50	Silty loam	127.563	98.125	1.30
10	NIH 1/100	Sandy loam	161.906	98.125	1.65
11	NIH 1/150	Sandy loam	141.300	98.125	1.44
12	SN 6/2/50	Sandy loam	150.131	98.125	1.53
13	SN 6/2/100	Loamy sand	158.963	98.125	1.62
14	SN 6/2/150	Sandy loam	139.338	98.125	1.42
15	SN 7/1/50	Sandy loam	153.075	98.125	1.56
16	SN 7/1/100	Sandy loam	149.150	98.125	1.52
17	SN 7/1/150	Loamy sand	168.775	98.125	1.72

Using the value of bulk density, porosity was calculated. The type of soil was determined from the soil texture triangle using sand, silt and clay percentage. To estimate soil suction (in cm), the formula given in equation (4.10) was used. Volumetric water content in percentage was determined from the graph (Figure 4.6). Estimated saturated hydraulic conductivity was found by using equation (4.11).

Table 5.2: Estimated and measured Hydraulic Conductivity of soils of West Bengal.

Sl. (1)	Site (2)	Depth (cm) (3)	Soil Type (4)	Dry Bulk Density (5)	Porosity (6)	Water Ret.at -33KPa (7)	Eff. Por. (8)	Estimated K _s (cm/hr) (9)	Measured K _s (cm/hr) (10)
1	Kalyani	50	Sandy loam	1.476	0.443	0.207	0.236	3.283	2.930
2	Kalyani	100	Sandy loam	1.496	0.435	0.207	0.228	2.883	3.167
3	Kalyani	100	Sandy loam	1.528	0.423	0.207	0.216	2.320	3.485
4	Saguna	50	Sandy loam	1.561	0.411	0.207	0.204	1.830	0.985
5	Saguna	50	Sandy loam	1.592	0.399	0.207	0.192	1.445	1.120
6	Saguna	100	Silty loam	1.515	0.428	0.33	0.098	0.099	2.614
7	Saguna	150	Sandy loam	1.471	0.445	0.207	0.238	3.389	1.930
8	Birohi	50	Silty clay	1.489	0.438	0.387	0.051	0.007	0.168
9	Birohi	150	Sandy loam	1.69	0.362	0.207	0.155	0.615	1.390
10	Gayespur	50	Silty clay	1.278	0.518	0.387	0.131	0.309	0.207
11	Mullavila	100	Clay loam	1.54	0.419	0.318	0.101	0.110	0.040
12	Mullavila	150	Sandy loam	1.452	0.452	0.207	0.245	3.817	8.970
13	Barajaguli	100	Silty loam	1.511	0.430	0.33	0.100	0.105	0.634
14	S.K.Pur	50	Sandy loam	1.456	0.451	0.207	0.244	3.724	8.214
15	S.K.Pur	100	Loamy sand	1.343	0.493	0.125	0.368	19.447	19.000
16	Katavile	50	Silty loam	1.484	0.440	0.33	0.110	0.155	0.919

Col(6) : Porosity = $1 - BD/PD = 1 - Col(5)/2.65$

Col(7) : Water retained at -33 KPa (from table 4.1)

Col(8) : Col(6) - Col(7)

Col(9) : Estimated K_s using equation, $1058 [Col(8)]^4$.

Col(10): Measured K_s by using Guelph Permeameter.

Table 5.3: Estimated and Measured Hydraulic Conductivity of Soils of the Study Area.

Sl.	Sample	Sand (%)	Silt (%)	Clay (%)	Texture	Bulk Density	Porosity	Soil suction (cm)	Initial W.C % (by vol)	Water Ret -33 KPa	Effective Porosity	Estimated Hyd. Cont(Ks) (cm/hr)	Measured Gneuph K(cm/hr)	Deg. of Sat.	K/Ks W.C basis
(1)	(2)	(3)	(4)	(5)	(6)	(7)	(8)	(9)	(10)	(11)	(12)	(13)	(14)	(15)	(16)
1	SN 2/1/50	60	34.86	5.14	Sandy loam	1.52	0.426	142.71	24.0	0.207	0.219	2.45	0.09	0.563	0.0933
2	SN 2/1/100	85	9.93	5.07	Loamy sand	1.69	0.362	451.11	12.0	0.125	0.237	3.35	NR	0.331	0.0044
3	SN 2/1/150	62	32.24	5.76	Sandy loam	1.49	0.438	156.92	23.5	0.207	0.231	3.00	NR	0.537	0.0747
4	SN 2/2/50	48	48.10	3.90	Silty loam	1.40	0.472	83.72	39.0	0.330	0.142	0.43	NR	0.827	0.4810
5	SN 2/2/100	39	57.17	3.83	Silty loam	1.39	0.475	59.56	40.0	0.330	0.145	0.47	NR	0.841	0.5151
6	SN 6/1/50	50	46.98	3.02	Sandy loam	1.48	0.442	94.71	27.0	0.207	0.235	3.20	1.27	0.612	0.1361
7	SN 6/1/100	58	36.41	5.59	Sandy loam	1.55	0.415	128.50	25.0	0.207	0.208	1.98	0.035	0.602	0.1271
8	SN 6/1/150	65	30.16	4.84	Sandy loam	1.63	0.385	175.65	23.0	0.207	0.178	1.06	NR	0.598	0.1227
9	NIH 1/50	46	49.00	5.00	Silty loam	1.30	0.509	73.55	39.5	0.330	0.179	1.10	NR	0.775	0.3720
10	NIH 1/100	56	39.93	4.07	Sandy loam	1.65	0.377	124.79	25.0	0.207	0.170	0.89	0.05	0.663	0.1932
11	NIH 1/150	63	33.34	3.66	Sandy loam	1.44	0.457	181.63	26.5	0.207	0.250	4.11	1.08	0.580	0.1075
12	SN 6/2/50	57	39.34	3.66	Sandy loam	1.53	0.423	128.16	20.0	0.207	0.216	2.29	2.82	0.473	0.0398
13	SN 6/2/100	73	23.13	3.87	Loamy sand	1.62	0.389	272.92	15.0	0.125	0.264	5.11	NR	0.386	0.0126
14	SN 6/2/150	71	23.32	5.68	Sandy loam	1.42	0.464	290.77	21.5	0.207	0.257	4.63	9.83	0.463	0.0356
15	SN 7/1/50	62	33.32	4.68	Sandy loam	1.56	0.411	157.12	21.5	0.207	0.204	1.84	1.77	0.523	0.0656
16	SN 7/1/100	70	25.75	4.25	Sandy loam	1.52	0.426	252.30	21.0	0.207	0.219	2.45	NR	0.492	0.0489
17	SN 7/1/150	88	8.83	3.17	Sand	1.72	0.351	573.93	10.0	0.091	0.260	4.83	3.69	0.285	0.0012

Col(9) = using equation 4.10;
Col(13) = using equation 4.11;

Col(10) = using graph from figure 4.6;
Col(15) = Col(10)/Col(8)*100;

Col(11) is from table 4.1;
Col(16) = using equation 4.12.

Col(12) = Col(8)-Col(11);

The saturated hydraulic conductivity in silty loam, sandy loam and loamy sand varies in the range 0.2-2.0 cm/hr, 2.0-5.0 cm/hr and 5.0-10.0 cm/hr respectively. Comparison of measured K_s and estimated K_s is furnished below:

Table 5.4: Estimated and measured (K_s).

Sl (1)	Soil Texture (2)	Effective Porosity(%) (3)	Estimated K_s (cm/hr) (4)	Measured K_s (cm/hr) (5)
1.	Sandy loam	21.9	2.45	0.090
2.	Loamy sand	23.7	3.35	NR
3.	Sandy loam	20.4	1.84	NR
4.	Silty loam	14.2	0.43	NR
5.	Silty loam	14.5	0.47	NR
6.	Sandy loam	23.3	3.20	1.270
7.	Sandy loam	20.8	1.98	0.035
8.	Sandy loam	17.8	1.06	NR
9.	Silty loam	17.9	1.10	NR
10.	Sandy loam	25.7	4.63	0.050
11.	Sandy loam	25.0	4.11	1.080
12.	Sandy loam	21.6	2.29	2.820
13.	Loamy sand	26.4	5.11	NR
14.	Sandy loam	17.0	0.89	9.830
15.	Sandy loam	15.9	0.68	1.770
16.	Sandy loam	21.9	2.45	NR
17.	Loamy sand	26.0	4.83	3.690

NR ⇒ No result.

Column(3) = Total porosity obtained from soil bulk density minus soil water content at 33 KPa suction pressure.

The estimated K_s values are in conformity which is within the range. The graph saturated hydraulic conductivity v/s effective porosity is showing a non linear trend in case

of estimated K_s . But, the measured K_s by Guelph Permeameter is not giving a best fit curve. The values are scattered with higher percent deviation as compared with estimated one (Figure 5.1).

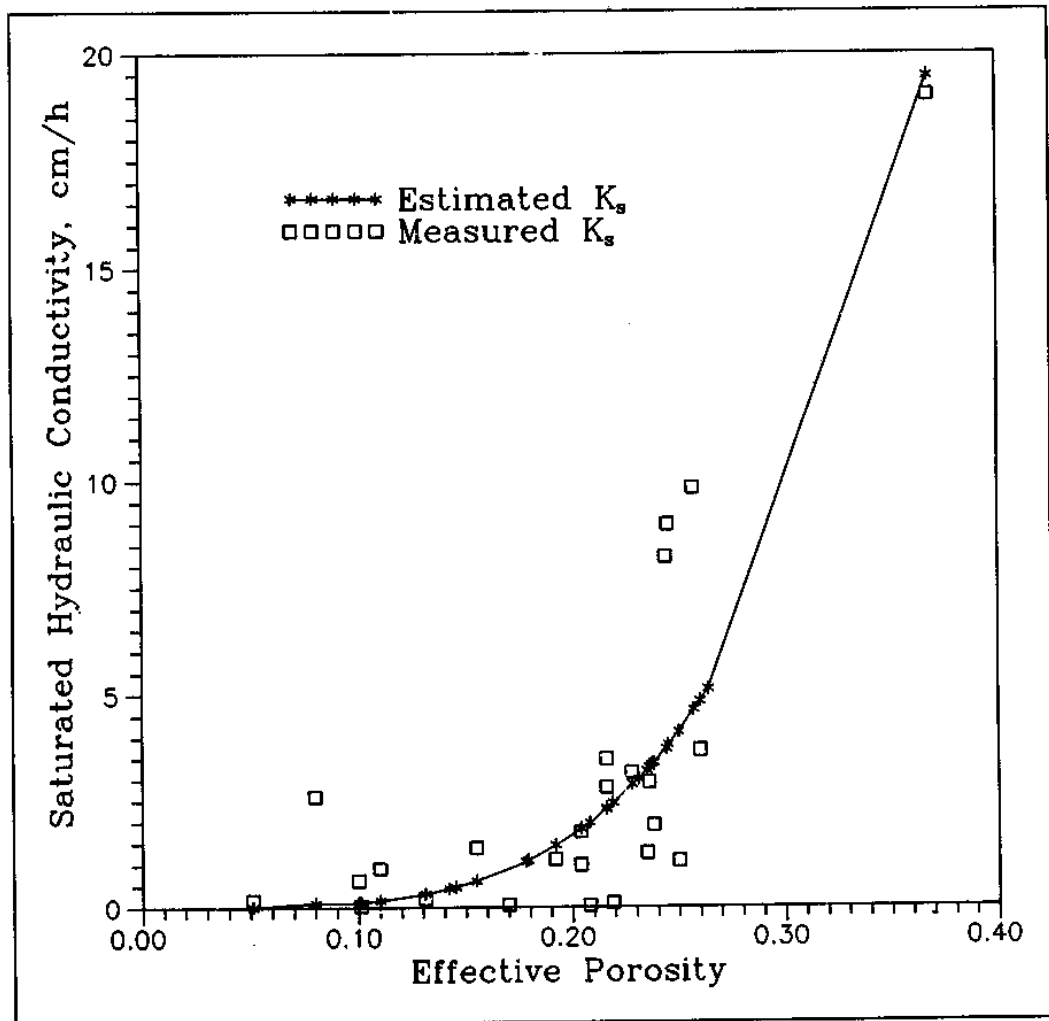

Figure 5.1: Effective Porosity v/s Estimated K_s and measured K_s Curve.

At 17 places GP was used to measure saturated K . But, it did not work in 8 places. The 9 sites where GP was operational were showing very low permeability from estimated value. Silt percentage in the study area is more (25-50%). This is causing smearing effect in the well hole wall and thus restricting the flow. Therefore the measured K_s value is lower

than the estimated values. Graph silt percentage v/s saturated K_s (Figure 5.2) is self explanatory.

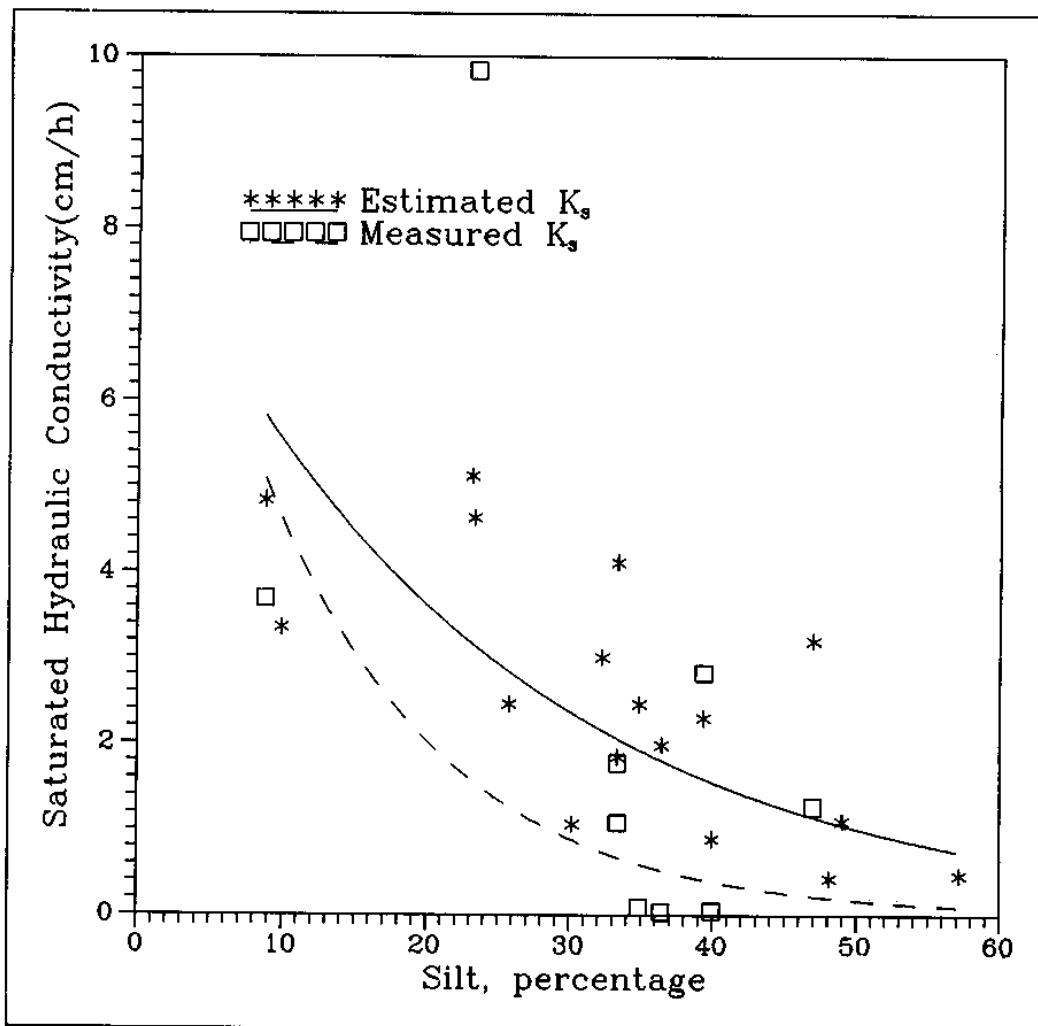

Figure 5.2: Silt Percentage v/s Saturated Conductivity Curve.

The unsaturated hydraulic conductivity (K) can be determined on moisture content basis by using the equation (4.12). The graph K/K_s v/s degree of saturation (Figure 5.3) may be referred.

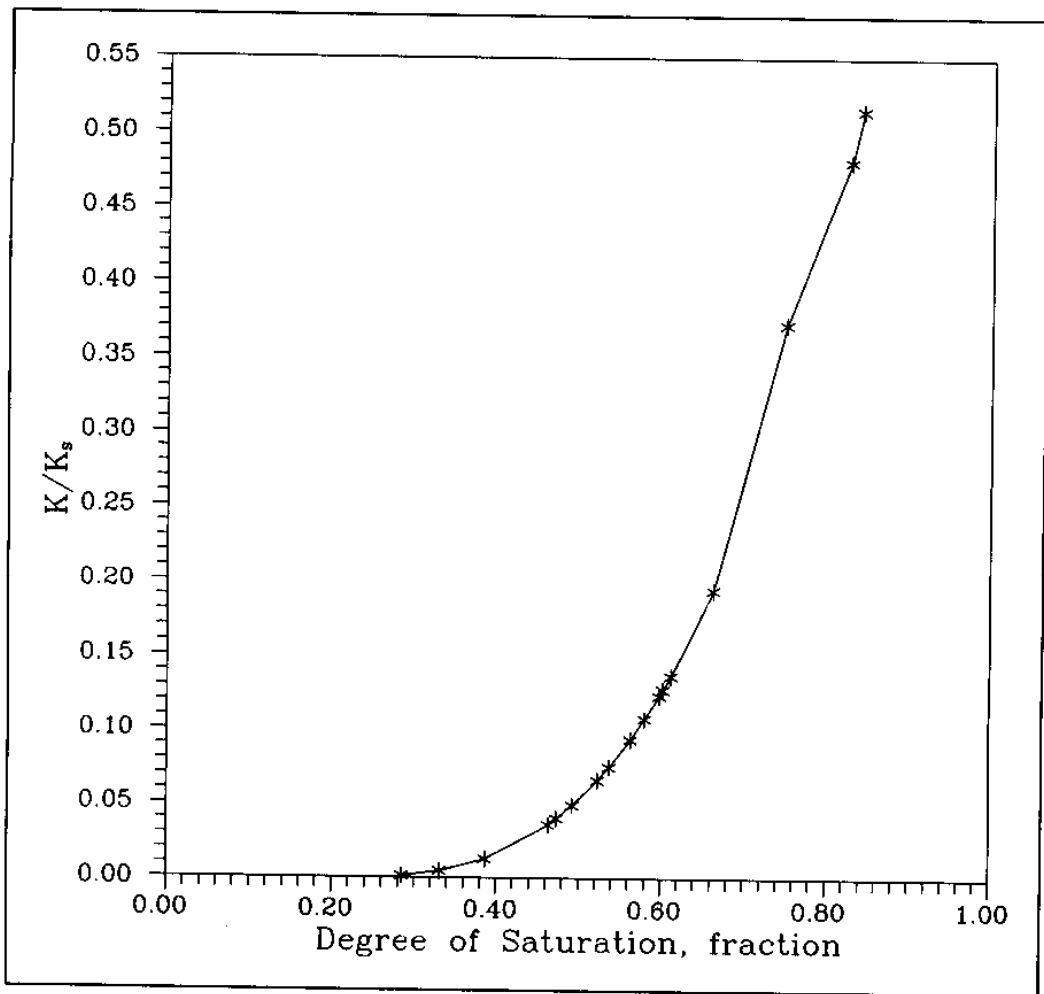

Figure 5.3: Unsaturated Hydraulic Conductivity estimated from the graph K/K_s v/s Degree of Saturation.

Lee, et al. (1985) measured saturated hydraulic conductivity of sandy loam and clayey soils with the help of air entry permeameter (AEP) and Guelph Permeameter. For a particular soil GP method yielded lower K_s value than AEP method.

GP method fails in sandy loam soil, because at some sites flow capacity of the permeameter is restricted due to the presence of entrapped air under field condition. On clayey soils failure occur under wet condition due to smearing of well surfaces by auger (Saha, Biplab. 1992 ,pp 20)

Dorsey, et al. (1990) made a comparison of the GP, the velocity permeameter, a pumping test procedure and the auger hole method for measuring saturated hydraulic conductivity (K_s). The results are compared for loam and silty clay loam soil. The pumping test and auger hole method provided results within similar ranges whereas Guelph Permeameter provided significantly low values.

GP's basic theory neglects the effect of unsaturated flow. This situation seldom exists in the in situ soil condition. Original GP theory is a special case when there is no capillary action. Therefore, GP method gives substantial error in determining saturated K_s in heavy textured soil (sandy loam to clay soils).

In this study area GP method could not give satisfactory result which might be due to the following reasons:

- Soil is mainly sandy loam type and sticky. Presence of high silt content and organic matter prohibit water transmission.
- Poor drainage condition of the land.
- Shallow water table.
- Might be presence of hard pan or clay lens underneath.

The in situ hydraulic conductivity is found lower as compared to the estimated one due to the following reasons:

- The area is situated besides a canal escape, which is at higher elevation than the agricultural field(study area). Due to low land and improper drainage, the water movement is restricted and slowly permeable.
- GP method is applicable where water table is deep and measurements are taken above water table. This is a dry auger hole method. In the study area due to waterlogged condition at some places, the ideal situation was absent.

6.0 RECOMMENDATIONS

The GP method can easily be employed due to its portability and durability. It allows rapid calculation of saturated hydraulic conductivity in the field. The water requirement for experimentation is also less (5 litre approx.).

However, GP method does not appear to be suitable for soils exhibiting strong heterogeneity, particularly in a vertical direction within the depth of water standing in the hole. If the bottom of the hole contains two distinct layers or is intercepted by macropores such as rat holes or root channels etc., the saturated hydraulic conductivity will be negative, which is physically unrealistic.

Ragab, R., and D. Cooper (1993) found that refilling the permeameter during a run, is in principle possible, but experiences show that for coarser sub-surface material results become unreliable if this is done. This may be due to air entrapment and/or hysteresis effects. Thus soils with high saturated hydraulic conductivity, the reservoir size of the Guelph Permeameter is a limiting factor. Smearing of the soil within the hole can not be eliminated entirely but may be minimised by suitable choice of auger and auguring under relatively dry condition.

The predictive methods (using empirical formulae) offer an attractive alternative to field methods. This method uses simple parameters which can be easily obtained from field investigations. This method do not take into account soil structure explicitly but uses the soil bulk density and porosity, which are structure dependent. The equation developed by Ahuja et.al, used in this study (equation 4.11) is very simple and effective.

Based on the experiences in the present study, following recommendations can be made:

- i. Extensive field studies by Guelph Permeameter is necessary in different soil types. More stress however may be given to heavy textured soils.
- ii. Hydraulic conductivity may be calculated in the field itself and if it is found unrealistic, the experiment need to be repeated in the close proximity at the same depth.
- iii. Setting the Guelph at different depths in the same location and taking average of the

hydraulic conductivity obtained at each depth may be representative to the profile. It is advisable to study the soil survey report of the area or study the soil profile by auguring before using Guelph Permeameter.

- iv. The locations may be selected for homogeneous soil.
- v. Soil cores of the same location and depths may be brought in the laboratory and the hydraulic conductivity can be determined by using ICW Permeameter. This result compared with the one obtained by Guelph Permeameter. The result can also be verified with the one obtained from the predictive methods. This will provide an in depth understanding of the problem and reliability of Guelph.

7. REFERENCES

- Chachadi, A.G., and G.C.Mishra., 1984-85. *Review Notes, RN-9, NIH, Roorkee*, pp-28.
- Dorsey, J.D., A.D.Ward., N.R.Fausey., and E.S.Bair. 1990. *A Comparison of four field methods for measuring Hydraulic Conductivity*. Transactions of the ASCE, 33 (6), pp 1925-1931.
- David, R. Maidment., 1992. *Handbook of hydrology*. McGraw Hill, New York, pp 5.1-5.43
- Erenst, L.F., 1950. *A New Formulae for the Calculation of the Permeability Factor with the Auger Hole Method*. Agri. Exp. Station, T.N.O. Groningen, The Netherlands.
- Irmay, S., 1954. *Hydraulic Conductivity of Unsaturated Soils*, Trans. American Geophysical Union, V 35, pp 463-467.
- Manual on Guelph Permeameter., 1987. Soil Moisture Equipment Corporation, Santa Barbara, CA 93105, USA.
- Manual on ICW Permeameter., 1983. Eijkelkamp, Agrisearch Equipment. The Netherlands.
- Mishra, G.C., 1996. *Drainage Manual*. NIH publication, Roorkee, pp 77-92.
- Ragab, R., and J.D.Cooper., 1993. *Variability of Unsaturated Zone Water Transport parameters: Implications for Hydralogical Modelling*. Elsevier Science Publications, Journal of Hydrology, 148 (1993), pp 133-147.
- Renolds, W.D., and D.E.Elrick., 1985. *In situ Measurement of Field Saturated Hydraulic Conductivity, Sorptivity, and α - parameter using the Guelph Permeameter*. Journal of Soil Science, 140(4), pp 292-302.
- Saha, B., 1992. *Studies on Crop Yield in Arid zone Environment under Different Irrigability Classes*. Unpublished Phd Thesis, IARI, New Delhi, pp 70-75.

GANGA PLAINS NORTH REGIONAL CENTRE, PATNA

Director : **Dr. S.M. Seth**
Co-ordinator : **Dr. K.K.S. Bhatia, Scientist'F'**
Head : **Mr. N.C. Ghosh, Scientist'E'**

Study Group : **Mr. Biswajit Chakravorty, Scientist'C'**
: **Mr. N.G. Pandey, Scientist'B'**
Assisted by : **Mr. A.K. Sivadas, Technician.**